

3807-2RS

Angular contact ball bearing

Schaeffler ID:
0008215940000

Angular contact ball bearing 38..-B-2RS-TVH, double row, seals, plastic cage

Technical information

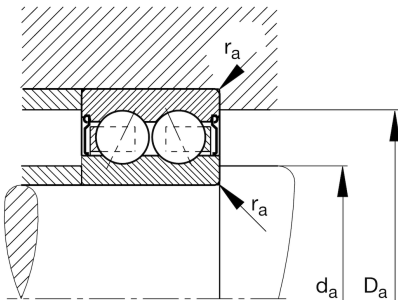
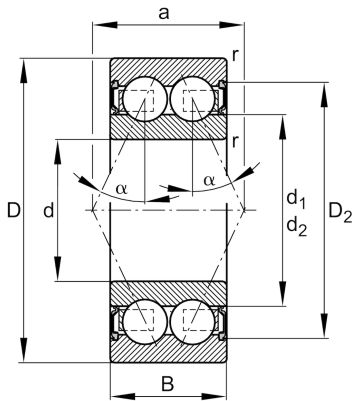

Main Dimensions & Performance Data

d	35 mm	Bore diameter
D	47 mm	Outside diameter
B	10 mm	Width
C_r	6,500 N	Basic dynamic load rating, radial
C_{0r}	6,800 N	Basic static load rating, radial
C_{ur}	375 N	Fatigue load limit, radial
n_G	7,000 1/min	Limiting speed
	0.041 kg	Weight

Dimensions

r_{min}	0.3 mm	Minimum chamfer dimension
D_2	44.1 mm	Caliber diameter outer ring
d_2	37.6 mm	Caliber diameter inner ring
a	22.6 mm	Distance between the apexes of the pressure cones
α	25 °	Contact angle

Mounting dimensions

$d_{a min}$	37 mm	Minimum diameter shaft shoulder
$D_{a max}$	45 mm	Maximum diameter of housing shoulder
$r_{a max}$	0.3 mm	Maximum fillet radius

Temperature range

T_{min}	-20 °C	Operating temperature min.
T_{max}	100 °C	Operating temperature max.